

兰帕特
LanParte



**AB STOPS
FOLLOW FOCUS**

FF-02

USER MANUAL

Lanparte AB stop follow
focus FF-02

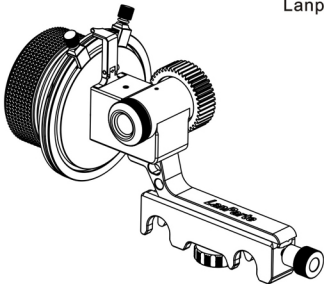

weight:
510g

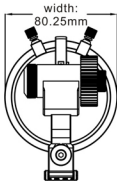

side view

Height:
109.6mm

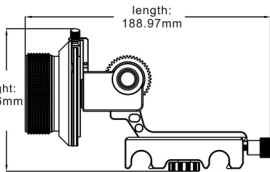

front view

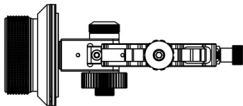

bottom view

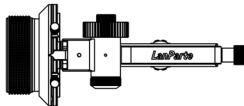

top view

AB stops switch

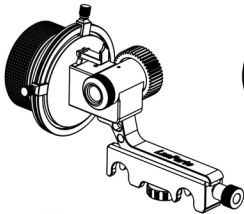

ABStops On

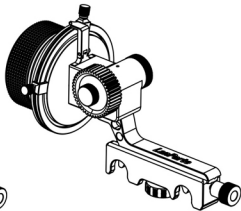

AB stops off

To disable the AB Stops, you can release the switch. This will allow the FF-02 to function as a normal Follow Focus unit.

AB stops function

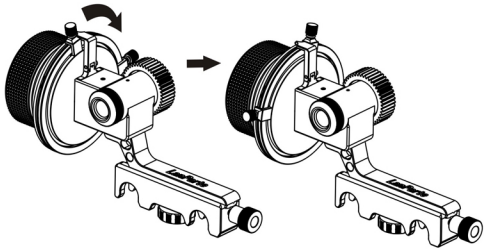

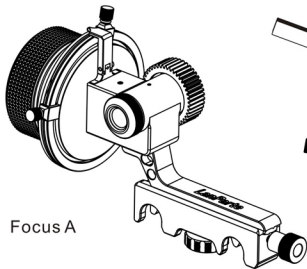

Focus A

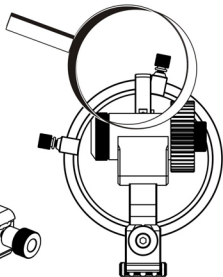

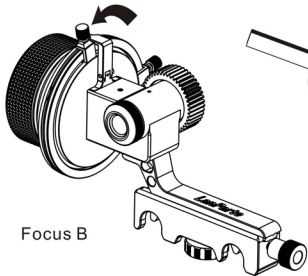

Focus B

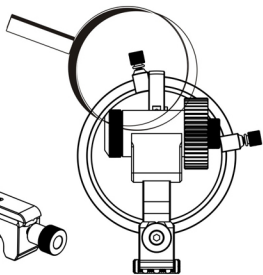

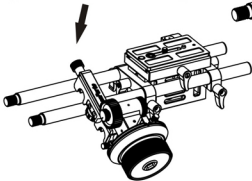
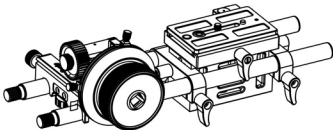
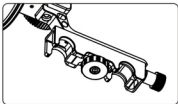

How to use the Quick Release Clamp

1. Unscrew the side knob
2. Snap the FF-02 on the rods
3. Screw the side knob to fasten it on rods

Standard Arri port

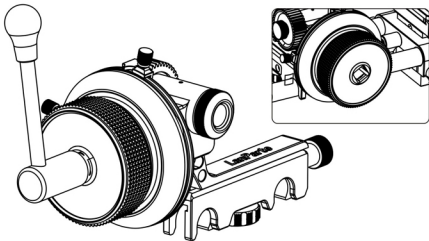

Fits the Focus Whip and Speed Crank as well as any accessories which fit the ARRI standard port.

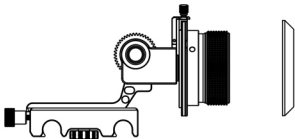

We use a magnet to attach the dial to the focus wheel. This means that if the dial is scratched or damaged, you can easily replace it with a new one.

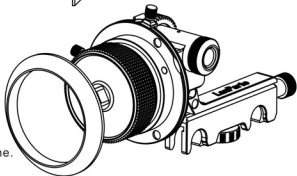

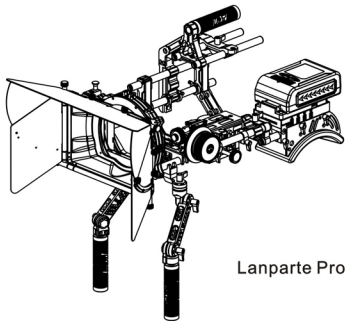

Lanparte Pro kit V2

HongKong Lanparte Technology Limited

Tel :+86-769-81888368

Fax :+86-769-85841828

Email:info@lanparte.com

Add :39#, xin'an 2nd Road Chang'an Town
Dongguan City Guangdong China(PRC)

<http://www.lanparte.com>

Hotline:+86-400-602-6822